

AutoScan Inspec2

Automatic Desktop 3D Scanner



Metrology-Grade Accuracy

With a scan accuracy of 0.01 mm, it ensures consistent, reliable results for complex small objects.

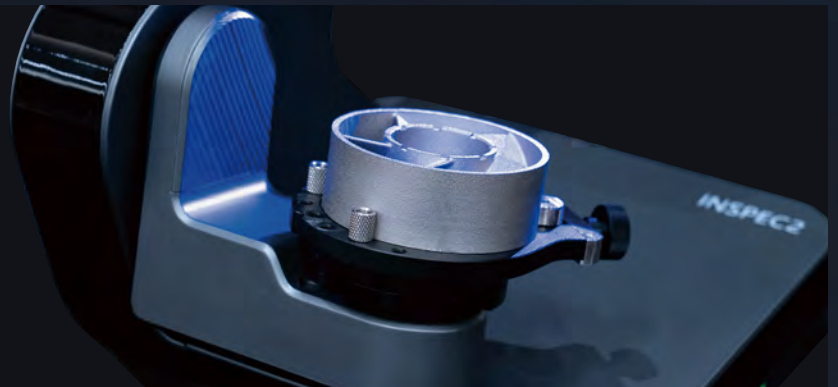

Automatic & Efficient

Features 3-axis turntable, enabling hands-free, multi-angle scanning with one-click operation to capture data efficiently.



Ultra-Fine Details

Equipped with dual 5MP high resolution cameras, it can capture every detail of the components meticulously.



Full Color Scanning

Captures true-to-life colors to ensure accurate texture reproduction for enhanced inspection, documentation, and digital modeling for various applications.



Advanced Software

Powered by UltraScan software, AutoScan Inspec2 delivers AI intelligent scanning algorithm for effortless operation. With broad compatibility across SHINING3D Inspec, Geomagic Control X, Design X, PolyWorks, EXModel and more, it streamlines workflows for quality inspection and reverse engineering.

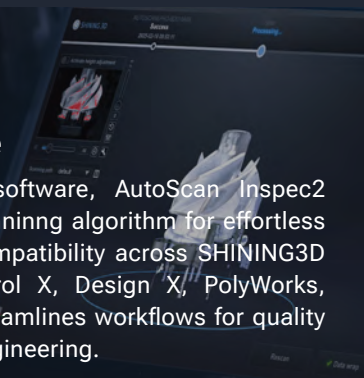

Compact & Lightweight

Weighing only 5 kg, its streamlined, space-saving design makes it easy to integrate into laboratories, workshops, and industrial environments.

Only **5 kg**



SHINING3D Inspect is a 3D inspection module that has received dual measurement accuracy certification from PTB (Physikalisch-Technische Bundesanstalt) for both Gaussian and Chebyshev software standards in length measurement.

Combined with it, AutoScan Inspec2 provides a streamlined workflow from scanning to inspection, enabling users to perform dimensional analysis, GD&T inspection, and generate professional reports.

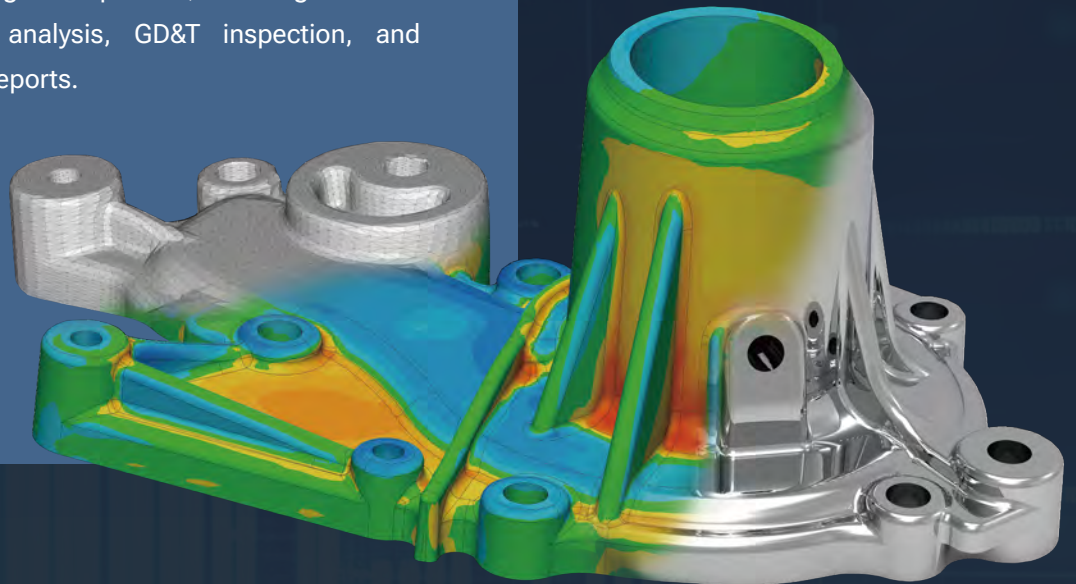

Key Features



Multi-Format Data Import and Management



2D Dimensions Inspection



Multi Alignment Toolset



Measurement Toolset



2D & 3D Comparison



Customized Reporting



GD&T Evaluation



Cross-Section Analysis Toolset



Intelligent Feature Recognition

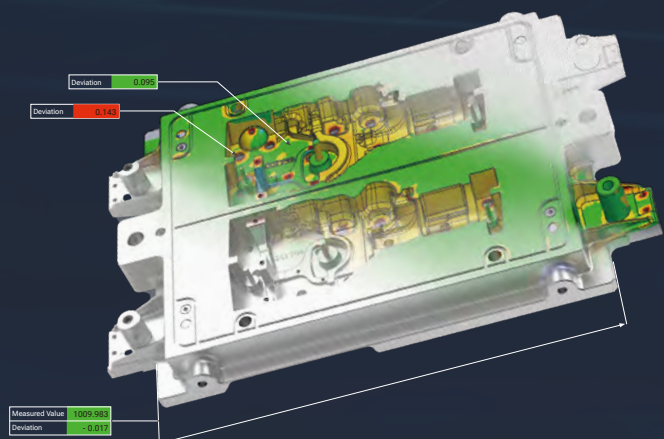



GD&T Inspection

Equipped with powerful GD&T tools, this feature enables precise measurement of feature diameter, position, orientation, distances and angles between features. An intuitive 3D display provides clear visual feedback for comprehensive analysis.



Auto Inspect

Auto Inspect provides an integrated scan-to-inspection solution, significantly enhancing efficiency. It supports batch processing of inspections, making it ideal for high-volume tasks and ensuring consistent, automated quality control.



3D Mesh Inspection

Import scanned data and employ multiple alignment methods for comprehensive 3D / 2D comparisons and other inspection functionalities. This feature supports full field inspection, allowing for thorough analysis of your mesh data.



Customizable Reports

SHINING3D Inspect allows users to customize inspection templates based on their specific requirements. This flexibility enables standardized, professional reporting tailored to various workflows and industries.

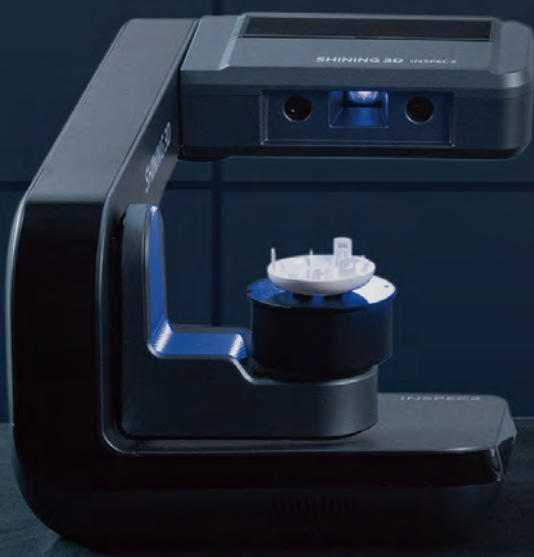

Versatile Applications

- Quality Control

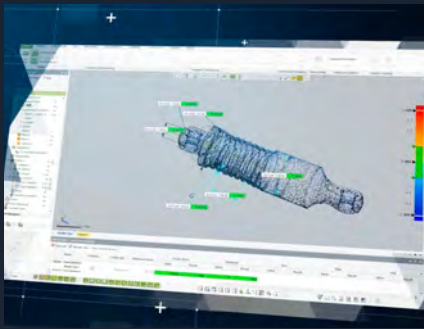

- Reverse Engineering

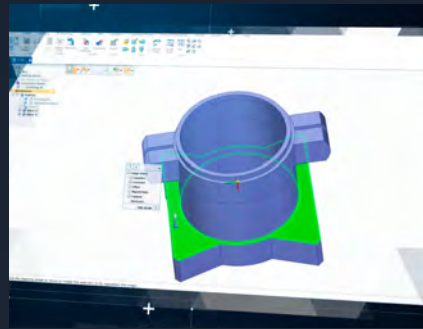

- Product Design



- Jewelry



- Heritage Preservation



- Healthcare



Specifications

Product	AutoScan Inspec2
Accuracy	0.01 mm
Field of view	140 × 90 × 80 mm
Align mode	Feature, Markers
Point distance	0.05 mm
Rotation axis	3 Axis
Camera resolution	2 × 5MP
Light source	LED blue light
Color scan	Supported
Dimensions	420 × 260 × 270 mm
Weight	5 kg
Power	DC 24V
Work temperature	0 ~ 40 °C
Operation system	Windows 10 / Windows 11 (64 bits)
Output format	STL, OBJ, PLY
Certification	CE, FCC, ROHS, WEEE, KC



Facebook



Instagram



LinkedIn



YouTube



SHINING 3D

www.shining3d.com
sales@shining3d.com